



Model Number:
F-WGC6-714177

RF Components

C-Band Waveguide Filter

6535-6575MHz

Physical Dimensions ($\pm 0.3\text{mm}$)

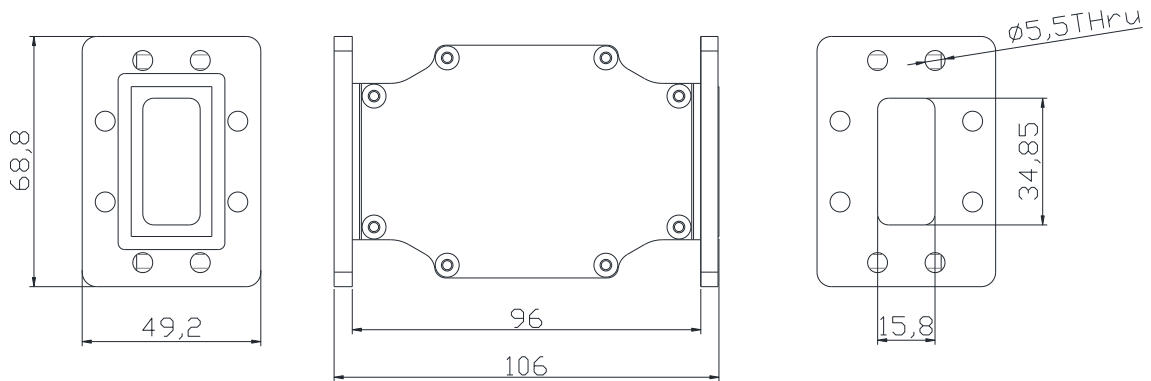

Filter

RF Parameters	
F-WGC6-714177	CGCF
Connectors	CPR137F/ CPR137G
Band Pass Frequencies	6535-6575 MHz
Rejection	$\geq 70\text{dB}$ @ 6665-6705MHz $\geq 70\text{dB}$ @ 6405-6445MHz
Insertion Loss	$\leq 1\text{dB}$
Return Loss	$\geq 22\text{dB}$
Flatness	$\leq 0.25\text{dB}$ @ 6535-6575MHz
Group Delay	$\leq 19\text{ns}$ @ 6535-6575MHz
Group Delay Variation	$\leq 2\text{ns}$ @ 6535-6575MHz

Environmental	
Operating Temperature	-40 °C to +45°C
Location	For Indoor or Outdoor use
IP Rating	IP66
Power Handling	50W

Broadcast



Marine Oil & Gas



SNG & VSAT



Satellite Teleport

