



Model Number:  
**F-WGC6-714178**

RF Components

# C-Band Waveguide Filter

6665-6705MHz

Physical Dimensions ( $\pm 0.3\text{mm}$ )

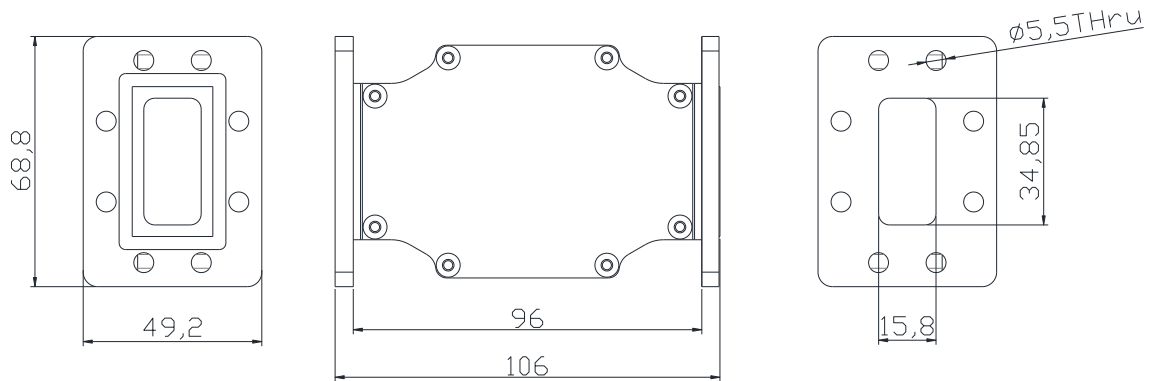

# Filter

RF Parameters	
F-WGC6-714178	CGCF
Connectors	CPR137F/ CPR137G
Band Pass Frequencies	6665-6705 MHz
Rejection	$\geq 70\text{dB}$ @ 6535-6575MHz $\geq 70\text{dB}$ @ 6795-6835MHz
Insertion Loss	$\leq 1\text{dB}$
Return Loss	$\geq 22\text{dB}$
Flatness	$\leq 0.25\text{dB}$ @ 6665-6705 MHz
Group Delay	$\leq 19\text{ns}$ @ 6665-6705 MHz
Group Delay Variation	$\leq 2\text{ns}$ @ 6665-6705 MHz

Environmental	
Operating Temperature	-40 °C to +45°C
Location	For Indoor or Outdoor use
IP Rating	IP66
Power Handling	50W

## Broadcast



## Marine Oil & Gas



## SNG & VSAT



## Satellite Teleport

