



RF Components

L-band Passive Equaliser

850 - 2150 MHz

Model Number:
EQU1P-4533

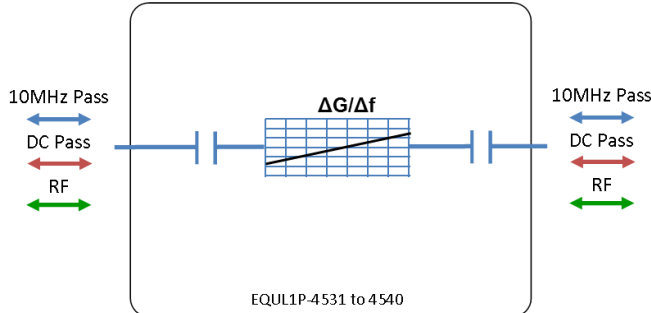

- Reciprocal device
- DC & 10MHz pass between the two ports
- 3dB positive slope

Available with RF connector options:

- 75 Ω BNC
- 75 Ω F-type.



RF Parameters		
EQU1P-4533-xxxx	B7B7	F7F7
Frequency Range	850 - 2150 MHz	
RF Connectors	75Ω BNC	75Ω F-Type
Mean Insertion Loss (dB)	Typ.	2.5
	Max.	3.5
Slope Positive (dB)	3.0 ± 0.8	3.0 ± 0.8
Input Return Loss (dB)	Typ.	14
	Min	8
Output Return Loss (dB)	Typ.	14
	Min	8

Broadcast



Marine Oil & Gas



SNG & VSAT



Satellite Teleport





RF Components

Model Number:
EQUL1P-4533
L-band Passive Equaliser

Environmental	
Operating Temperature	0°C to +65°C
Storage Temperature	-20°C to +75°C
Location	Indoor use Only
Humidity	Max 90% non-condensing
Altitude	Max 10,000 feet

Max Operating Parameters	
Input RF Power	+37 dBm (5W)
DC Voltage	28 V
DC Current	3 A

! Operation beyond these limits may cause instantaneous and permanent damage.

Physical Dimensions (mm)

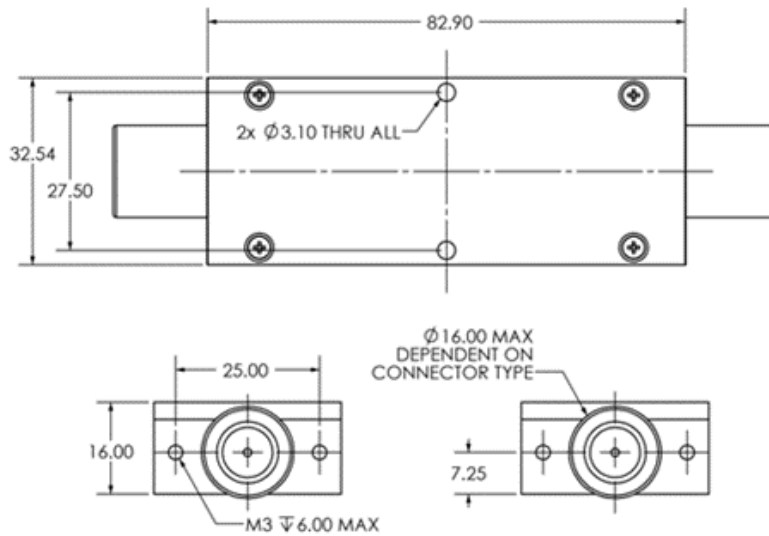

Note: The specification is subject to regular reviews and will be updated from time to time as part of our continuing product development and improved specification accuracy.

ETL SYSTEMS LIMITED
Coldwell Radio Station
Madley
Hereford
England HR2 9NE

TELEPHONE
+44 (0)1981 259020

EMAIL
info@etlsystems.com

FACSIMILE
+44 (0)1981 259021

WEB
www.etlsystems.com

